



IL BAGNO **ALESSI**

One

design Stefano Giovannoni
(2002, 2010, 2014)

LAUFEN

Bathroom Culture since 1892  www.laufen.com



MIRROR 120 • 4.4843.1
WASHBASIN 120 • 8.1497.4
VANITY UNIT 100 • 4.2450.0

ILBAGNOALESSI

One

design Stefano Giovannoni
(2002, 2010, 2014)

Born in 2002 from the creativity of famous Italian designer Stefano Giovannoni, IIBagnoAlessi One is one of Laufen's most successful collections. Based in 15 years of successful co-operation between Laufen and Alessi, the range is one of the most complete and sustainable ever produced on an industrial scale. The IIBagnoAlessi One collection is continuously being enriched with new elements and designs, from countertops and freestanding washbasins to bathtubs, from toilets to the furnishings and accessories made in our world class SaphirKeramik.

Laufen, global leader in designer sanitary ware, has always combined its solid commitment to crafting the highest quality products with its passion for experimentation and its great capacity for technological innovation. At all stages Laufen uses exceptional raw materials and highly skilled labour.

The additional IIBagnoAlessi One range recognises the increasing importance of great design for compact spaces, offering solutions that provide comfort and style in smaller environments as well as in more spacious interiors.

The creative and inspiring IIBagnoAlessi One collection is a highly innovative and growing project, which, according to Alberto Alessi, "Stefano was able to freely and adroitly draw from the extensive vocabulary of forms that have been made available to human kind, creating objects that are at once more striking and more human".

IIBagnoAlessi One wurde im Jahr 2002 vom italienischen Star-Designer Stefano Giovannoni entworfen und ist eine der erfolgreichsten Kollektionen in der 15-jährigen Zusammenarbeit zwischen Laufen und Alessi. Sie setzt Massstäbe hinsichtlich Vielfalt und Langlebigkeit der Produkte und wird regelmässig in alle Richtungen erweitert: von Waschbecken zu Badewannen, von WCs zu weiterer Badezimmer-Einrichtung und Zubehör, alles gefertigt aus dem einzigartigen SaphirKeramik Material.

Schon immer verbindet Laufen, das weltweit führende Unternehmen für Baddesign, höchstes Engagement bei der Entwicklung und Produktion seiner hochwertigen Produkte mit seiner klaren Berufung zum Experimentieren. Dies wird erreicht durch kontinuierliche Erforschung neuer Rohstoffe und hohe Ansprüche an die Spezialisierung und Qualifizierung der Mitarbeiter.

Die Erweiterung zu IIBagnoAlessi One bietet Produkte auch in kleineren Grössen an und trägt damit der aktuellen Entwicklung hin zu kleineren Badezimmern Rechnung. Damit werden Komfort und Design auch in kompakteren Räumen ermöglicht.

Dank langjähriger Erfahrung in der Keramikherstellung und der kontinuierlichen, kreativen Kraft stellt die Kollektion IIBagnoAlessi One ein extrem innovatives, expandierendes Projekt dar, das laut Alberto Alessi auf der besonderen Fähigkeit von Giovannoni basiert, „geschickt aus dem umfangreichen Formenvokabular zu schöpfen, das dem Menschen zur Verfügung steht, um immer humanere und einprägsamere Badobjekte zu entwerfen.“

Née en 2002 de la créativité du célèbre designer italien Stefano Giovannoni, IIBagnoAlessi One est l'une des collections les plus appréciées de la marque et parmi les plus complètes et durables jamais réalisées à l'échelle industrielle. La gamme, qui continue de s'agrandir au fil des ans avec de nouveaux éléments, s'étend à tous les niveaux: des lavabos à poser et indépendants aux baignoires, des sanitaires jusqu'aux éléments d'ameublement et aux accessoires en SaphirKeramik.

Depuis toujours, Laufen, l'entreprise suisse leader dans la fabrication de sanitaires design, maîtrise un savoir-faire dans le développement de produits de grande qualité grâce à la recherche de l'excellence dans le choix de ses matériaux et à l'emploi d'une main-d'œuvre hautement qualifiée, avec pour vocation l'innovation constante et la capacité de se maintenir à la pointe de la technologie.

Une attention toute particulière a d'ailleurs été récemment portée sur les contraintes posées par un environnement aux espaces de plus en plus restreints. Pour y remédier: des éléments aux dimensions réduites et permettant d'allier confort et design, même dans les plus petits espaces. Fruit du savoir-faire dans la fabrication de céramique et dans un désir de créativité sans cesse renouvelée, la collection IIBagnoAlessi One est le pilier d'un projet en pleine expansion et à forte valeur innovante. Comme

Alberto Alessi souligne: "Stefano a été capable de créer des objets qui sont à la fois plus impactant et plus humains".

Nato nel 2002 dalla creatività del noto designer italiano Stefano Giovannoni, IIBagnoAlessi One è una delle collezioni di maggior successo dell'azienda, nonché una tra le proposte più complete e longeve mai realizzate su scala industriale. La gamma, che continua a crescere arricchendosi nel corso degli anni di sempre nuovi elementi, spazia in ogni direzione: dai lavabi consolle e free standing alle vasche da bagno, dai sanitari fino ai complementi d'arredo e agli accessori in SaphirKeramik.

Da sempre Laufen, azienda svizzera leader nel bagno di design, coniuga il grande impegno nello sviluppo di prodotti di altissima qualità, possibile grazie alla ricerca dell'eccellenza nelle materie prime e all'impiego di manodopera altamente specializzata, con la sua chiara vocazione alla sperimentazione e la sua grande capacità di innovazione tecnologica.

Grande attenzione è stata recentemente posta, inoltre, nei confronti delle necessità determinate da ambienti sempre meno ampi, proponendo anche elementi in dimensioni ridotte e permettendo così di avere comfort e design anche in piccoli spazi.

Frutto del know-how nella produzione di ceramiche e del costante sforzo creativo, la collezione IIBagnoAlessi One rappresenta un progetto in espansione fortemente innovativo. Come sottolinea Alberto Alessi, "Stefano ha saputo attingere con libertà e maestria al grande vocabolario delle forme che sono state messe a disposizione dell'uomo per creare degli oggetti insieme più emozionanti e più umani".



BATHTUB 180 • 2.4597.2
MIRROR 120 • 4.4843.1
WASHBASIN BOWL 80 • 8.1897.3
WASHTOP 120 • 4.2311.1
DRAWER ELEMENT 40 • 4.2440.2
WALLHUNG BIDET • 8.3097.1
SAPHIRKERAMIK TOILET PAPER HOLDER • 8.7097.0
WALLHUNG WC • 8.2097.6
SEAT AND COVER • 8.9297.1

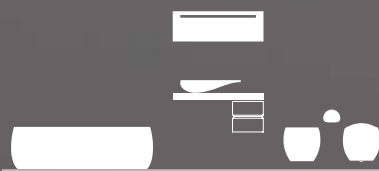





Solid Surface, freestanding bathtub in soft and comfortable shapes, with or without whirl system. Also available in a fitted version.

Freistehende Badewanne aus Mineralgusswerkstoff in sanfter, komfortabler Form, mit oder ohne Whirlsystem. Auch als Einbauversion erhältlich.

Baignoire indépendante en Solid Surface aux formes délicates et harmonieuses, avec ou sans système balnéo. Également disponible en version encastrable.

Vasca centro stanza in Solid Surface dalle forme morbide e avvolgenti, con o senza idromassaggio. Disponibile anche nella versione da incasso.



The washbasin icon of this collection is now also available in a 90cm and 120cm left or right countertop version, especially suitable for smaller spaces.

Der ikonische Waschtisch aus der Kollektion ist auch als unterbaufähiger Waschtisch links oder rechts von 90 cm oder 120 cm erhältlich, besonders für kleinere Räume geeignet.

Le lavabo, élément phare de la collection, désormais est aussi disponible en version encastrable gauche ou droite de 90 cm et 120 cm, particulièrement adaptée à de plus petits espaces.

Il lavabo icona della collezione è ora disponibile anche nella versione consolle destra o sinistra da 90 cm e 120 cm, particolarmente adatta a spazi più piccoli.

MIRROR CABINET 65 • 4.4812.1
WASHBASIN 90 • 8.1497.5
VANTIY UNIT 73 • 4.2447.0





Eye-catching design: 400 mm high "half Tam Tam".
The free-standing washbasin bowl makes a great impression.

Zieht Blicke auf sich: Der 400 mm hohe „halbe Tam Tam“.
Als freistehende Waschtischschale hinterlässt er einen starken Eindruck.

Attire tous les regards: le «semi Tam Tam» haut de 400 mm.
Utilisé comme lavabo à poser non encastré, il fait forte impression.

Un mobile che attira tutti gli sguardi: il "mezzo Tam Tam" alto 400 mm.
Questa bacinella per centro stanza esercita un forte impatto visivo.



MIRROR 160 • 4.4844.1
HALF TAM TAM • 8.1197.3
WASHTOP 160 • 4.2321.1
VANITY UNIT 80 • 4.3021.1







- BATHTUB 180 • 2.4597.2
- MIRROR 2x120 • 4.4843.1
- WASHBASIN BOWL 80 • 8.1897.3
- VANITY UNIT 240 • 1x4.2460.4 / 2x4.2417.0
- SAPHIRKERAMIK HANGER • 8.7097.6
- WALLHUNG BIDET • 8.3097.1
- SAPHIRKERAMIK TOILET PAPER HOLDER • 8.7097.2
- WALLHUNG WC • 8.2097.6
- SEAT AND COVER • 8.9297.1



“Like the idea of a white stone polished by water”

Stefano Giovannoni



WASHBASIN BOWL 80 • 8.1897.3
VANITY UNIT 120 • 4.2416.1





MIRROR FRAME 200 • 4.4742.0
LAMP, HORIZONTAL 200 • 4.4756.2
SAPHIRKERAMIK SHELF
TOWEL HOLDER • 8.7097.2
WASHBASIN BOWL 80 • 8.1897.3
WASHTOP 200 • 4.2325.4
BATHTUB 180 • 2.4597.2



“Objects that are at once more striking and more human”

Alberto Alessi



WASHBASIN 120 • 8.1497.6
VANITY UNIT 120 • 8.2445.0

SAPHIRKERAMIK SHELF TOWEL HOLDER • 8.7097.2





The collection is enriched with new accessories with functional and symbolic value, including a towel shelf made of the revolutionary SaphirKeramik. Also available are a toilet paper holder and a towel hook.

Die Kollektion wird durch neue Accessoires von funktionalem und symbolischen Wert ergänzt, unter anderem durch die Ablage mit Handtuchschlitz, gefertigt aus der revolutionären SaphirKeramik. Erhältlich sind auch Papierrollenhalter und Aufhänger.

La collection s'enrichit de nouveaux accessoires à la portée autant symbolique que fonctionnelle, comme l'étagère avec porte-serviette en céramique révolutionnaire, la SaphirKeramik. Sont également disponibles le porte-rouleau WC et le crochet.

La collezione si arricchisce di nuovi accessori dal valore e funzionale e simbolico, tra cui la mensola con portasciugamani realizzata con la rivoluzionaria SaphirKeramik. Disponibili anche il portarotolo e il gancio portasciugamani.



URINAL • 8.4097.1
COVER • 8.9497.1



SAPHIRKERAMIK HANGER • 8.7097.6
SAPHIRKERAMIK TOILET PAPER
HOLDER • 8.7098.0
SIPHONIC ONE PIECE WC • 8.2397.0
SEAT AND COVER • 8.9297.1

WALL-HUNG BIDET • 8.3097.1
SAPHIRKERAMIK TOILET PAPER
HOLDER • 8.7098.0
WALL-HUNG WC • 8.2097.6
SEAT AND COVER • 8.9297.1









BATHTUB 180 • 2.4597.2
 HIGH CABINET 170 • 4.5801.2
 MIRROR 120 • 4.4843.1
 WASHBASIN 120 • 8.1497.4
 VANITY UNIT 100 • 4.2450.0
 SAPHIRKERAMIK HANGER • 8.7097.6
 FLOORSTANDING WC COMBINATION • 8.2297.6
 SAPHIRKERAMIK TOILET PAPER HOLDER • 8.7098.0
 SEAT AND COVER • 8.9297.1



“Il Bagno Alessi One” really seems to be a timeless archetype, fashionable yet not following any particular style, like something created by nature itself”

Stefano Giovannoni



Born in La Spezia (Italy) in 1954, architect and designer Stefano Giovannoni now lives and works in Milan.

His internationally acclaimed, multi-award winning work, some of which can be found in the permanent collections of the Centre Georges Pompidou in Paris and the Museum of Modern Art in New York. For Alberto Alessi, the managing director of ALESSI, Giovannoni is one of the few designers capable of combining the extraordinary with the popular.

This is indeed the reason that he commissioned him to develop ALESSI's first complete bathroom scenario.

Der 1954 in La Spezia (Italien) geborene Architekt und Designer Stefano Giovannoni lebt und arbeitet in Mailand. Sein Schaffen wurde mehrfach international ausgezeichnet. Einige seiner Werke finden sich in den permanenten Sammlungen des Centre Georges Pompidou in Paris sowie des Museum of Modern Art in New York. Für Alberto Alessi, den Geschäftsführer von ALESSI, ist Giovannoni einer der wenigen Designer, die es verstehen, das Aussergewöhnliche mit dem Populären zu verbinden. Das ist auch der Grund, weshalb er ihn mit der Entwicklung des ersten kompletten Badezimmerszenarios für ALESSI beauftragte.

L'architecte et designer Stefano Giovannoni, né en 1954 à La Spezia (I), vit et travaille à Milan. Ses oeuvres ont maintes fois été reconnues sur le plan international. Quelques-unes de ses créations sont exposées dans des collections permanentes au Centre Georges Pompidou à Paris et au Museum of Modern Art à New York. Pour Alberto Alessi, directeur d'ALESSI, Giovannoni est l'un des rares designers en mesure de relier l'exceptionnel au populaire. C'est aussi la raison pour laquelle il l'a chargé de développer le premier concept complet de salle de bains pour ALESSI.

L'architetto e designer Stefano Giovannoni, nato a La Spezia (I) nel 1954, vive e lavora a Milano. Le sue creazioni sono state più volte premiate a livello internazionale. Alcune delle sue opere fanno parte della collezione permanente del Centre Georges Pompidou a Parigi e sono esposte al Museum of Modern Art di New York. Per Alberto Alessi, titolare di ALESSI, Giovannoni è uno dei pochi designer in grado di combinare quanto c'è di più straordinario con gli aspetti più popolari. E questo è anche il motivo per cui lo ha incaricato della creazione della prima collezione completa per il bagno di ALESSI.



WASHBASIN 160 • 8.1497.1





This washbasin ripples like a wave over the furniture element. Its ceramic shelf provides an easy-to-clean storage area for bottles and soap. With hidden overflow hole, with or without tap hole.

Wie eine Welle flutet dieser Waschtisch über das zugehörige Möbel. Seine keramische Ablage lässt sich als reinigungsfreundliche Stellfläche für Flakons und Seifen verwenden. Mit verstecktem Überlauf, mit oder ohne Hahnloch.

Ce lavabo vient lécher telle une vague le meuble correspondant. Sa tablette en céramique s'utilise comme surface de pose facile à nettoyer pour les flacons et les savons. Avec trop-plein caché, avec ou sans trou pour la robinetterie.

Questo lavabo fluttua come un'onda sul mobiletto sottostante. La sua mensola in ceramica, facile da pulire, è l'ideale per riporvi flaconi e sapone. Con troppopieno nascosto, con o senza foro per la rubinetteria.



MIRROR 160 • 4.4844.1
WASHBASIN 160 • 8.1497.1
VANITY UNIT 130 • 4.2436.0





The visual anchor and keynote design element of ILBAGNOALESSI One is the floorstanding washbasin, affectionately called Tam-Tam – for its likeness to a drum. Also available with wall-connection and as a “half Tam-Tam” washbasin bowl.

Der visuelle Anker und das bestimmende Design-Element von ILBAGNOALESSI One ist der bodenstehende Waschtisch, liebevoll Tam-Tam genannt – ähnelt er doch einer Trommel. Auch erhältlich mit Wandanbindung und als “halb Tam-Tam” Aufsatz-Waschtisch.

TAM TAM • 8.1197.2





HALF TAM TAM • 8.1197.3
WASHTOP 160 • 4.2321.2



Le lavabo au sol, affectueusement surnommé Tam-Tam, est l'ancrage visuel et l'élément déterminant du design de ILBAGNOLESSI One, même s'il ressemble à un tambour. Disponible aussi avec raccordement au mur et en version vasque à poser "demi Tam-Tam".

Icona del design é il lavabo centro stanza, confidenzialmente chiamato Tam-Tam, per la sua somiglianza con lo strumento musicale. Disponibile anche con connessione a parete e come bacinella "mezzo Tam-Tam".



BATHTUB 200 • 2.4197.0
MIRROR 160 • 4.4844.1
HALF TAM TAM • 8.1197.3
WASHTOP 160 • 4.2321.4 + 4.2300.0





MIRROR 160 • 4.4844.1
SEMI-RECESSED WASHBASIN 75 • 8.1397.2
VANITY UNIT 120 • 4.2415.2
VANITY UNIT 120 • 4.2415.1

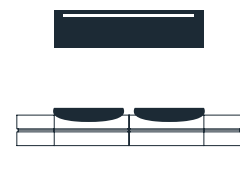



DROP-IN WASHBASIN 50 • 8.1397.1
VANITY UNIT 120 • 4.2414.2



WALLHUNG BIDET • 8.3097.1
WALLHUNG WC • 8.2097.6







IlBagnoAlessi One washbasin bowls elegantly combine with the vanity units with drawers and mirror cabinets.

Die Aufsatz-Waschtische aus der Kollektion IlBagnoAlessi One sind mit dem Unterbau und Schubladen und dem Spiegelschrank elegant kombinierbar.

Les vasques à poser de la collection IlBagnoAlessi One s'intègrent de manière élégante aux meubles de lavabos avec tiroirs et aux meubles à miroir.

Le bacinelle della collezione IlBagnoAlessi One si abbinano elegantemente alle basi con cassetti e agli specchi contenitori.



MIRROR CABINET 65 • 4.4811.1 + 4.4812.1
WASHBASIN BOWL 75 • 8.1897.2
WASHTOP 240 • 4.2462.4
VANITY UNIT 120 • 4.2418.0
VANITY UNIT 120 • 4.2417.0

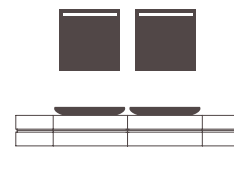



MIRROR 160 • 4.4844.1
WASHBASIN 160 • 8.1497.1
BATHTUB 200 • 2.4497.0
BATHTUB BENCH 320 • 4.5851.2



The specially designed furniture for the sanitary acrylic bathtub in real wood veneer *noce canaletto* completes the bathroom range, with possible extensions on both sides and specially treated against water. Also available in white, the top plate is made of artificial marble.

Die speziell designte Ausstattung für die Acryl- Badewanne in Echtholz furnier *Noce Canaletto*, mit möglichen Erweiterungen auf beiden Seiten und speziell wasserabweisender Oberfläche, vervollständigt die Badezimmereinrichtung. Auch in Weiss, mit Oberplatte aus Kunstmarmor erhältlich.

Pour compléter l'ensemble de la salle de bains, le meuble conçu pour la baignoire en acrylique sanitaire est en plaqué *noce canaletto*, spécialement traité contre les moisissures, avec des extensions de chaque côté. Également disponible en blanc, la plaque supérieure est en marbre artificiel.

Il mobile in *noce canaletto*, appositamente disegnato per la vasca in acrilico sanitario, con possibili estensioni su entrambi i lati e trattato con una speciale vernice resistente all'acqua, completa la gamma degli arredi. Disponibile anche in bianco, con il top in marmo tecnico.

“The overall bathroom setting
is much more than just a place
where we clean our bodies”

Alberto Alessi



WASHBASIN 160 • 8.1497.1





MIRROR 160 • 4.4844.1
WASHBASIN 160 • 8.1497.1
VANITY UNIT 135 • 4.2436.0



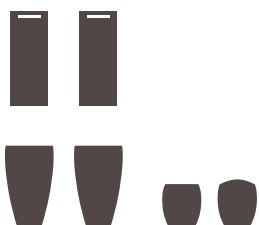

MIRROR 40 • 4.4841.1
FREESTANDING TAM TAM • 8.1197.2
FLOORSTANDING BIDET • 8.3297.1
FLOORSTANDING WC • 8.2197.1
SEAT & COVER • 8.9297.1



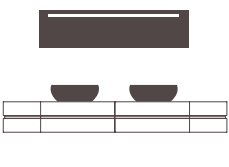

MIRROR 160 • 4.4844.1
 WASHBASIN BOWL • 8.1897.1
 WASHTOP 240 • 4.2462.4
 VANITY UNIT 120 • 4.2418.0
 VANITY UNIT 120 • 4.2417.0
 TIDY SYSTEM FOR DRAWER • 4.9240.2 + 2 x 4.9240.1



The furniture system allows for numerous combinations of containers, mirrors, basins and counters. In the noce canaletto version, a special double coating makes the surface extremely resistant to water.

Das Möbel-System ermöglicht zahlreiche Kombinationen aus Schränken, Spiegeln, Waschtischen und Ablageboards. Bei der Version Noce Canaletto sorgt eine spezielle Zwei-Komponenten-Lackierung für eine hohe Wasserbeständigkeit der Oberflächen.

L'ensemble des éléments de rangement, des miroirs, lavabos et tablettes peut s'agencer de nombreuses façons. Pour la version en noce canaletto, une double couche de vernis spécial rend les surfaces particulièrement étanches.

Il sistema di mobili consente numerose combinazioni tra contenitori, specchi, lavabi e piani d'appoggio. Nella versione noce canaletto, una speciale doppia verniciatura rende le superfici estremamente resistenti all'acqua.

Product Overview



1600 x 500 mm
shelf right



1200 x 500 mm
shelf right or left



900 x 500 mm
shelf right or left



420 x 465 mm
520 x 525 mm
600 x 525 mm



520 x 530 x 850 mm



wall-hung WC
585 x 390 mm



floorstanding WC
585 x 390 mm



floorstanding WC
combination
720 x 390



one piece WC
745 x 405 mm



urinal
(optional lid)



freestanding bathtub
solid surface
1830 x 870 mm



built-in bathtub
solid surface
1780 x 820 mm



freestanding bathtub
sanitary acrylic
2030 x 1020 mm



built-in bathtub
sanitary acrylic
2030 x 1020 mm



vanity unit for
countertop washbasin
900/1200/1600x320 mm



vanity unit
cut out central
800 x 500 mm



vanity unit
cut out left or right
1200 x 500 mm



vanity unit
cut out left and right
1600 x 500 mm



drawer element
without top
400 x 540 mm
800 x 500 mm



tall cabinet
400 x 300 x 1700 mm



mirror
400 x 1000 mm
800/1200/1600 x
400 mm



mirror cabinet
650 x 650 mm
800 x 650 mm

Product Overview



ø 530 x 900 mm
○ ●



ø 450 mm
●



800 x 425 mm
●



500 x 500 mm
520 x 520 mm
○ ●



750 x 500 mm, semi-recessed
750 x 520 mm
○ ●



wall-hung bidet
585 x 390 mm
●



floorstanding bidet
585 x 390 mm
●



shelf towel holder
632 mm



toilet paper holder



hanger



semi-recessed bathtub (left, center, right)
sanitary acrylic
2030 x 1020 mm



vanity unit
cut out left or right, or left & right
2400 x 500 mm



vanity unit for semi-recessed washbasin
center, left or right
800/1200 x 350 mm



washtop
cut out left, right,
left and right, center
600/800/1200/
1600/2000 x 500 mm



drawer element
with open top
400 x 350 mm
400 x 500 mm
800 x 350 mm
800 x 500 mm

○ no taphole
● 1 taphole



COLOURS CERAMICS
White LCC



COLOURS FURNITURE
Noce canaletto
White lacquered



COLOURS BATHTUBS
White



COLOURS SHOWER TRAYS
White antislip



OPTIONS SHOWER ENCLOSURES
transparent glass
transparent glass, antiplaque

ILBAGNOALESSI One



81497.5 ○/●
Countertop washbasin, shelf right
 Waschtisch unterbaufähig, Ablage rechts
 Lavabo à poser sur meuble, tablette à droite
 Lavabo consolle, mensola a destra

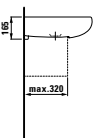
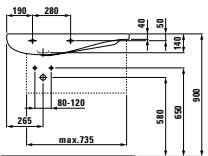
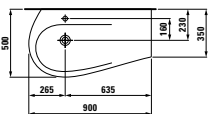

Colours: .400
 Options: .104 .109



81497.6 ○/●
Countertop washbasin, shelf left
 Waschtisch unterbaufähig, Ablage links
 Lavabo à poser sur meuble, tablette à gauche
 Lavabo consolle, mensola a sinistra

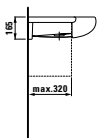
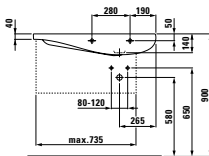
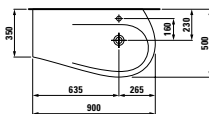

Colours: .400
 Options: .104 .109



81497.3 ○/●
Countertop washbasin, shelf right
 Waschtisch unterbaufähig, Ablage rechts
 Lavabo à poser sur meuble, tablette à droite
 Lavabo consolle, mensola a destra

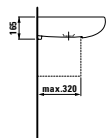
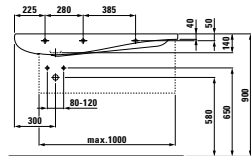
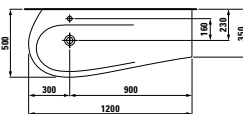

Colours: .400
 Options: .104 .109



81497.4 ○/●
Countertop washbasin, shelf left
 Waschtisch unterbaufähig, Ablage links
 Lavabo à poser sur meuble, tablette à gauche
 Lavabo consolle, mensola a sinistra

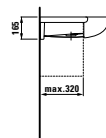
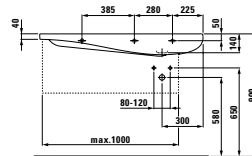
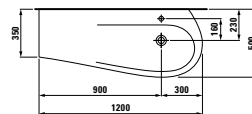

Colours: .400
 Options: .104 .109

ILBAGNOALESSI One



81497.1 /
Countertop washbasin, shelf right
 Waschtisch unterbaufähig, Ablage rechts
 Lavabo à poser sur meuble, tablette à droite
 Lavabo consolle, mensola a destra

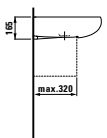
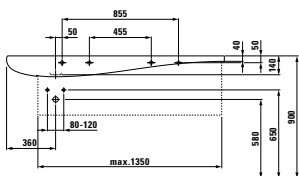
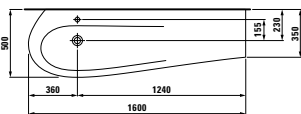

Colours: .400
 Options: .104 .109



81897.3 /
Washbasin bowl, shelf left or right
 Aufsatz-Waschtisch, Ablage links oder rechts
 Vasque à poser, tablette à gauche ou droite
 Bacinella, mensola a sinistra o a destra

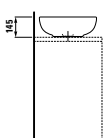
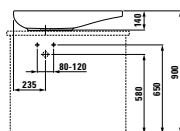
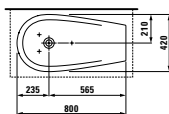

Colours: .400
 Options: .112



81197.3 /
Washbasin bowl
 Aufsatz-Waschtisch
 Vasque à poser
 Bacinella

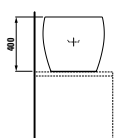
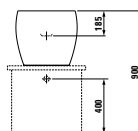
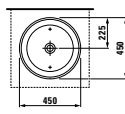

Colours: .400
 Options: .109



81197.2 /
Freestanding washbasin
 Waschtisch freistehend
 Lavabo indépendant
 Lavabo a centro stanza

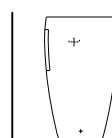
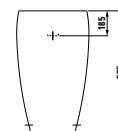
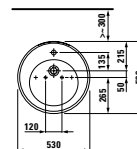

Colours: .400
 Options: .104 .109

ILBAGNOALESSI One



81197.1 ○/●

Floorstanding washbasin, with wall connection

Freistehender Waschtisch mit Wandanbindung
 Lavabo au sol avec raccordement au mur
 Lavabo centro stanza con connessione a parete

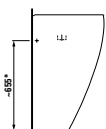
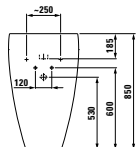
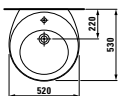

Colours: .400
 Options: .104 .109



81397.1 ○/●

Drop-in washbasin

Einbauwaschtisch von oben
 Lavabo à encastrer par-dessous
 Lavabo da incasso soprapiano

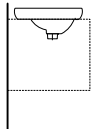
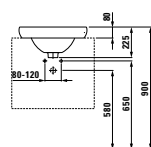
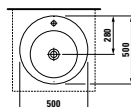

Colours: .400
 Options: .104 .109



81897.1 ○/●

Washbasin bowl

Aufsatz-Waschtisch
 Vasque à poser
 Bacinella

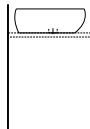
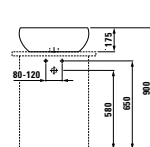
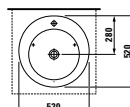

Colours: .400
 Options: .104 .109



81897.2 ○/●

Washbasin bowl

Aufsatz-Waschtisch
 Vasque à poser
 Bacinella

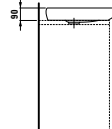
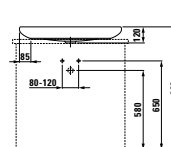
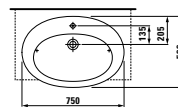

Colours: .400
 Options: .104 .109

ILBAGNOALESSI One



81397.2



Semi-recessed washbasin

Halbeinbauwaschtisch
Lavabo à semi-encastrer
Lavabo semincasso

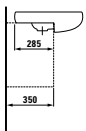
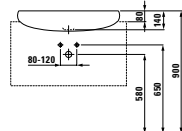
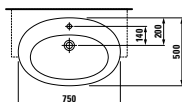

Colours: .400
Options: .104 .109



81597.0



Small washbasin, with integrated siphon cover

Handwaschbecken mit integrierter Siphonverkleidung
Lave-mains avec cache-siphon intégré
Lavamani con coprisifone integrato

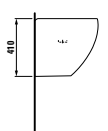
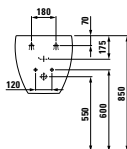
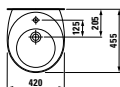

Colours: .400
Options: .104 .109



81097.1



Washbasin, with integrated siphon cover

Waschtisch mit integrierter Siphonverkleidung
Lavabo avec cache-siphon intégré
Lavabo con rivestimento integrato del sifone

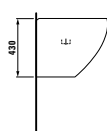
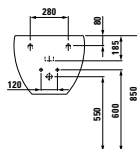
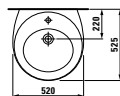

Colours: .400
Options: .104 .109



81097.2



Washbasin, with integrated siphon cover

Waschtisch mit integrierter Siphonverkleidung
Lavabo avec cache-siphon intégré
Lavabo con rivestimento integrato del sifone

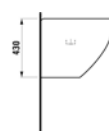
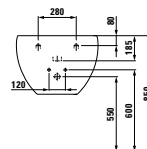
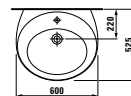

Colours: .400
Options: .104 .109

ILBAGNOALESSI One



87097.0
Toilet paper holder
Papierrollenhalter
Porte-Papier
Portarotolo







Colours: .000
Options: .000 .899



87097.6
Hanger
Aufhänger
Crochet
Portasciugamani

Colours: .000
Options: .000*



82097.6
Wall-hung WC, washdown
Wand-WC, Tiefspüler
WC suspendu, à chasse directe
Vaso sospeso, a cacciata





87097.2
Shelf with towel holder
Ablage mit Handtuchschlitz
Étagère avec porte-serviette
Mensola con portasciugamani





Colours: .000
Options: .000 .899

Options for accessories:
Optionen für Accessoires:
Options pour les accessoires:
Opzioni per accessori:

.000
Screwed mounting
Schraubmontage
montage à vis
montaggio a vite

***Screwed and glued mounting possible**
Schraub- und Klebmontage möglich
montage possible à vis et avec colle
montaggio possibile a vite e con collante

.899
Glued mounting
Klebmontage
montage avec colle
montaggio con collante



89297.1
Seat and cover, removable, with lowering system
WC-Sitz mit Deckel, abnehmbar, mit Absenkautomatik
Siège avec abattant, amovibles, avec frein de chute
Sedile con coperchio, rimovibile, con sistema a caduta rallentata

Colours: .000

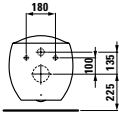
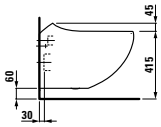
Colours: .400

ILBAGNOALESSI One



82197.1

Floorstanding WC, washdown, with horizontal or vertical outlet

Stand-WC, Tiefspüler, Abgang waagrecht/senkrecht
WC au sol à chasse directe, avec évacuation horizontale ou verticale
Vaso a pavimento, a cacciata, scarico orizzontale/verticale

4,5L 3L

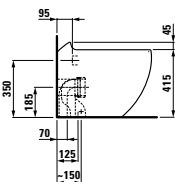
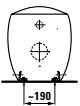
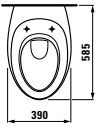

Colours: .400



82297.6

Floorstanding WC combination, washdown, Vario outlet

Stand-WC-Kombination, Tiefspüler, Vario Abgang
WC au sol avec réservoir, chasse directe, évacuation Vario
Vaso monoblocco a pavimento, a cacciata, scarico Vario

82697.1

Cistern, Dual Flush

Spülkasten, Dual-Flush
Réservoir, double chasse
Cassetta di risciacquo, Dual-Flush

4,5L 3L

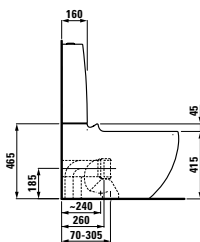
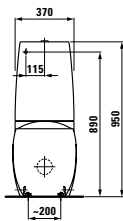
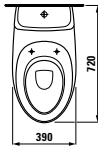

Colours: .400



82397.0

One-piece WC, siphonic, dual flush chrome push button

One-piece WC, siphonisch, verchromter Dual-Flush Druckknopf
Toilette monobloc, siphonique, bouton-poussoir chromé à double-chasse
Vaso monoblocco, sifonico, pulsante cromato dual-flush

Available from 3rd quarter 2016

Verfügbar ab 3. Quartal 2016
Disponibile dès 3^{ème} trimestre 2016
Disponibile dal 3° trimestre 2016

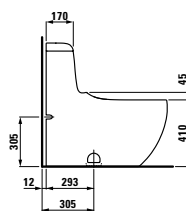
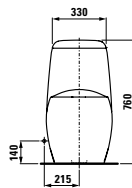
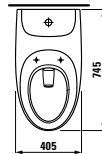

Colours: .400



82397.1

One-piece WC, siphonic, single flush side lever

One-piece WC, siphonisch, seitlicher Hebel für Single-Flush
Toilette monobloc, siphonique, levier lateral pour chasse simple
Vaso monoblocco, sifonico, leva laterale per sciacquo singolo

Available from 3rd quarter 2016

Verfügbar ab 3. Quartal 2016
Disponibile dès 3^{ème} trimestre 2016
Disponibile dal 3° trimestre 2016

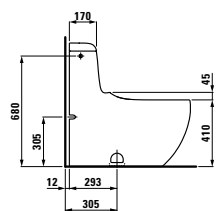
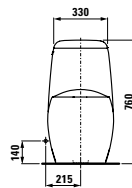
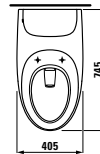

Colours: .400

ILBAGNOALESSI One



83097.1
Wall-hung bidet
 Wandbidet
 Bidet suspendu
 Bidet sospeso

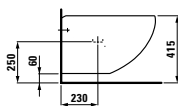
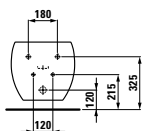
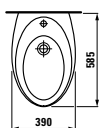

Colours: .400
 Options: .304



83297.1
Floorstanding bidet
 Standbidet
 Bidet au sol
 Bidet a pavimento

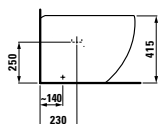
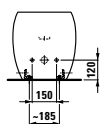
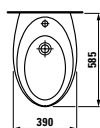

Colours: .400
 Options: .304



84097.5
Siphonic urinal
 Absauge-Urinal
 Urinoir à effet siphonique
 Orinatoio ad aspirazione

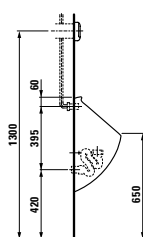
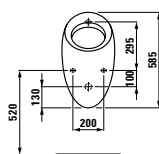

Colours: .400
 Options: .400



84097.1
Siphonic urinal, with holes for cover
 Absauge-Urinal, mit Löchern für Deckel
 Urinoir à effet siphonique, version pour abattant
 Orinatoio ad aspirazione, con fori per coperchio

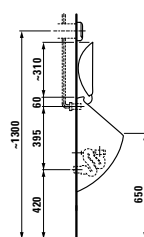
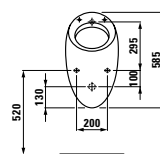

Colours: .400
 Options: .400

ILBAGNOALESSI One

Options for washbasins

Optionen für Waschtische
Options pour les lavabos
Opzioni per lavabi

.104 1 tap hole

- 1 Hahnloch
1 trou pour la robinetterie
1 foro per la rubinetteria

.109 Without tap hole

- Ohne Hahnloch
Non percé
Senza foro per la rubinetteria

Options for bidets

Optionen für Bidets
Options pour les bidets
Opzioni per bidet

.304 With 1 tap hole at centre

- Mit 1 Hahnloch mittig
Avec 1 trou pour la robinetterie
Con 1 foro rubinetteria al centro

Options for urinals

Optionen für Urinale
Options pour les urinoirs
Opzioni per orinatoi

.400 With fly

- Mit Fliege
Avec mouche
Con mosca

Colours ceramic

Farben Keramik
Couleurs céramique
Colori della ceramica

 **.000 White**
Weiss
Blanc
Bianco

 **.400 White LCC**
Weiss LCC
Blanc LCC
Bianco LCC



24597.1

Bathtub, solid surface material, 1780x820 mm, fitted version, with frame

Badewanne, Mineralgusswerkstoff, 1780x820 mm, Einbauversion, mit Fussgestell

Baignoire, en solid surface, 1780x820 mm, version encastrée, avec piètement

Vasca da bagno, in solid surface, 1780x820 mm, versione da incasso con base

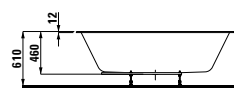
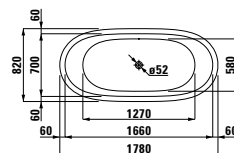

Colours: .000
Options: .000 .605 .615 .625



24597.2

Bathtub, solid surface material, 1830x870 mm, freestanding version, with lifting system

Badewanne, Mineralgusswerkstoff, 1830x870 mm, freistehend, mit Hubsystem

Baignoire, en solid surface, 1830x870 mm, version indépendante, avec système élévateur

Vasca da bagno, in solid surface, 1830x870 mm, versione a centro stanza, con sistema di sollevamento della vasca

For the installation of the bathtub a cut out in the floor is needed. Please see the technical fact sheet.

Zur Installation der Badewanne ist ein Bodenausschnitt erforderlich. Bitte technisches Datenblatt beachten.

Une découpe dans le sol est requise pour l'installation de la baignoire.

Pour plus de détails, merci de consulter la fiche technique.

Per l'installazione della vasca da bagno prevedere scasso a pavimento. Consultare le specifiche tecniche per maggiori informazioni.

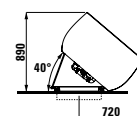
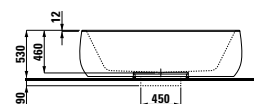
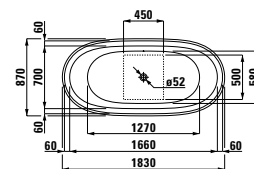

Colours: .000
Options: .000 .605 .615 .625

Colours bathtubs

24597.1 and 24597.2

Farben Badewannen

24597.1 und 24597.2

Couleurs baignoires

24597.1 et 24597.2

Colori delle vasche da bagno

24597.1 e 24597.2

 **.000 White**
Weiss
Blanc
Bianco

Options bathtubs

24597.1 and 24597.2

Optionen Badewannen

24597.1 und 24597.2

Options pour baignoires

24597.1 et 24597.2

Versioni delle vasche da bagno

24597.1 e 24597.2

.000

Without whirl system

Ohne Whirlsystem

Sans système balnéo

Senza sistema idromassaggio

.605 / .615 / .625

Whirl system with sensor

Whirlsystem mit Sensorsteuerung

Système balnéo avec capteur

Sistemi idromassaggio con sensore

Number of air holes

90

Anzahl Luftlöcher

Nombre de trous d'aération

Numero di fori di aerazione

ILBAGNOALESSI One



24397.0
Bathtub, sanitary acrylic, 2030x1020 mm, fitted version, with frame, also available with whirl system
 Badewanne, Sanitäracryl, 2030x1020 mm, Einbauversion, mit Fußgestell, auch mit Whirlsystem erhältlich
 Baignoire, acrylique sanitaire, 2030x1020 mm, version encastrée, sans tablier, avec piètement, également disponible avec système balnéo
 Vasca da bagno, acrilico sanitario, 2030x1020 mm, versione da incasso, con base, disponibile anche con sistema idromassaggio

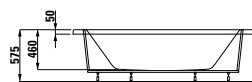
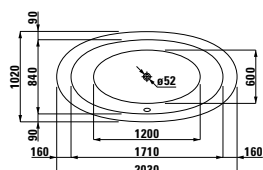

Colours: .000
Options: .000 .675 .695 .056 .057



24197.0
Bathtub, sanitary acrylic, 2030x1020 mm, freestanding version, with panel, also available with whirl system
 Badewanne, Sanitäracryl, 2030x1020 mm, freistehend, mit einteiliger Schürze, auch mit Whirlsystem erhältlich
 Baignoire, acrylique sanitaire, 2030x1020 mm, version indépendante, avec tablier, également disponible avec système balnéo
 Vasca da bagno, acrilico sanitario, 2030x1020 mm, versione a centro stanza, con pannello di rivestimento monopezzo, disponibile anche con sistema idromassaggio

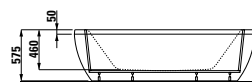
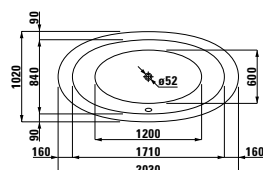

Colours: .000
Options: .000 .675 .695 .056 .057



24497.0
Bathtub, sanitary acrylic, 2030x1020 mm, semi-recessed version, with half panel, also available with whirl system
 Badewanne, Sanitäracryl, 2030x1020 mm, Halbeinbauversion, mit Frontschürze, auch mit Whirlsystem erhältlich
 Baignoire, acrylique sanitaire, 2030x1020 mm, version semi-encastrée, avec tablier frontal, également disponible avec système balnéo
 Vasca da bagno, acrilico sanitario, 2030x1020 mm, versione a semincasso, con semipannello di rivestimento, disponibile anche con sistema idromassaggio

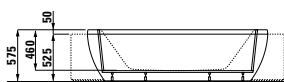
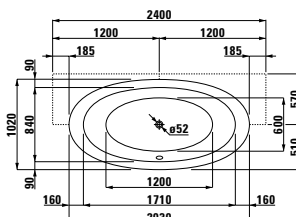

Colours: .000
Options: .000 .675 .695 .056 .057

Colours bathtubs

24197.0, 24397.0 and 24497.0
 Farben Badewannen
 24197.0, 24397.0 und 24497.0
 Couleurs baignoires
 24197.0, 24397.0 et 24497.0
 Colori delle vasche da bagno
 24197.0, 24397.0 e 24497.0



Options bathtubs

24197.0, 24397.0 and 24397.0
 Optionen Badewannen
 24197.0, 24397.0 und 24397.0
 Options pour baignoires
 24197.0, 24397.0 et 24397.0
 Versioni delle vasche da bagno
 24197.0, 24397.0 e 24397.0

.000

Without whirl system

Ohne Whirlsystem
 Sans système balnéo
 Senza sistema idromassaggio

.675 / .695

Whirl system with sensor

Whirlsystem mit Sensorsteuerung
 Système balnéo avec capteur
 Sistemi idromassaggio con sensore

Number of air holes 88

Anzahl Luftlöcher
 Nombre de trous d'aération
 Numero di fori di aerazione

Number of micro-nozzles 8

Anzahl Mikrodüsen
 Nombre de tuyères
 Numero di microbocchette

Number of side nozzles 6

Anzahl Seitendüsen
 Nombre de tuyères latérales
 Numero di bocchette laterali

ILBAGNOALESSI One

Options bathtubs with whirlsystem

Ausführungen Badewannen mit Whirlsystem

Exécutions des baignoires avec balnéo

Versioni delle vasche con sistema idromassaggio

.000 Without whirlsystem

Ohne Whirlsystem

Sans balnéo

Senza sistema idromassaggio

Whirlsystems with sensor

Elektronische Sensorsteuerung

Commande électronique avec détecteur

Sistemi idromassaggio con sensore

	Air massage /Luftmassage/Aéromassage/ Idromassaggio a getto d'aria	Hydromassage /Wassermassage/ Hydromassage/Idromassaggio aria/acqua	Disinfection /Desinfection/ Désinfection/Igienizzazione	Heating /Heizung/ Chauffage/Riscaldatore	LED light /LED-Licht/ Eclairage LED/Luce a LED	Steam /Dampf/Vapeur/Umidità	Display /Display/Affichage/Display	Music /Musik/Musique/Musica
Option .605	x							
Option .615					x			
Option .625	x				x			
Option .635		x						
Option .645	x	x						
Option .675	x	x			x			
Option .695	x	x	x		x			

ILBAGNOALESSI One



45851.1

Bathtub panel, for semi-recessed bathtub 24497.0, overall length 2400 mm

Badewannenpanel, für Halbeinbau-Badewanne 24497.0, gesamt 2400 mm

Tablier en bois, pour baignoire semi-encastrée 24497.0, longueur totale 2400 mm

Pannello per vasca da bagno a semincasso 24497.0, totale 2400 mm

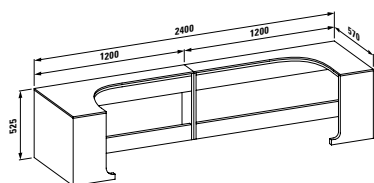

45851.4

Bathtub panel, for semi-recessed bathtub 24497.0, storage left and right, overall length 4000 mm

Badewannenpanel, für Halbeinbau-Badewanne 24497.0, Ablage links und rechts, gesamt 4000 mm

Tablier en bois, pour baignoire semi-encastrée 24497.0, rangement à gauche et à droite, longueur totale 4000 mm

Pannello per vasca da bagno a semincasso 24497.0, mensola a sinistra e a destra, totale 4000 mm

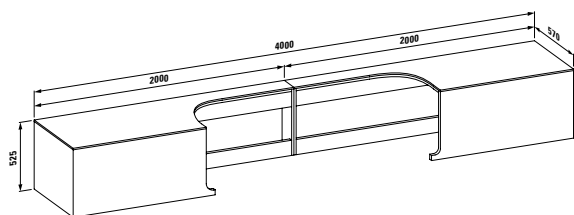

Colours: .630 .631



45851.2

Bathtub panel, for semi-recessed bathtub 24497.0, storage left, overall length 3200 mm

Badewannenpanel für Halbeinbau-Badewanne 24497.0, Ablage links, gesamt 3200 mm

Tablier en bois, pour baignoire semi-encastrée 24497.0, rangement à gauche, longueur totale 3200 mm

Pannello per vasca da bagno a semincasso 24497.0, mensola a sinistra, totale 3200 mm

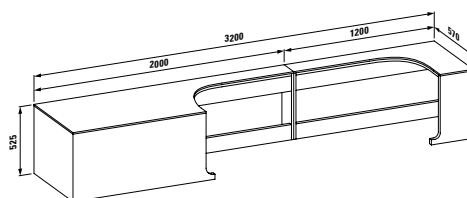

45851.3

Bathtub panel, for semi-recessed bathtub 24497.0, storage right, overall length 3200 mm

Badewannenpanel für Halbeinbau-Badewanne 24497.0, Ablage rechts, gesamt 3200 mm

Tablier en bois, pour baignoire semi-encastrée 24497.0, rangement à droite, longueur totale 3200 mm

Pannello per vasca da bagno a semincasso 24497.0, mensola a destra, totale 3200 mm

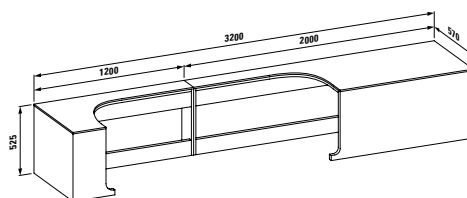

Colours: .630 .631

ILBAGNOALESSI One

Colours furniture

Farben Möbel

Couleurs meubles

Colori dei mobili



.631 White lacquered

Weiss lackiert











Blanc laqué

Bianco laccato









.630 Noce canaletto

Possible washbasin/washtop combinations

Washtop Waschtischplatte Plan de toilette Piano d'appoggio	800			1200			
Optional drawer elements Optionale Schubladenelemente Éléments tiroirs en option Elementi a cassetti opzionali	 42301.3	 42311.3	 42311.4	 42311.1	 42311.2	 42321.3	
Washbasin Waschtisch Lavabo Lavabo							
ILBAGNOALESSI ONE							
 81197.3 Ø 450 mm	●	●	●	●	●	●	●
 81897.1 Ø 520 mm	●	●	●	● /R Drawer element Schubladenelement Element tiroir Elementi a cassetti 42440.2	● /L Drawer element Schubladenelement Element tiroir Elementi a cassetti 42440.2	● /LR Drawer element Schubladenelement Element tiroir Elementi a cassetti 42440.2	
 81397.1 Ø 500 mm	●	●	●	● /R Drawer element Schubladenelement Element tiroir Elementi a cassetti 42440.2	● /L Drawer element Schubladenelement Element tiroir Elementi a cassetti 42440.2	● /LR Drawer element Schubladenelement Element tiroir Elementi a cassetti 42440.2	
 81897.2 750x520 mm	●	●		● /R Drawer element Schubladenelement Element tiroir Elementi a cassetti 42440.2	● /L Drawer element Schubladenelement Element tiroir Elementi a cassetti 42440.2	● /LR Drawer element Schubladenelement Element tiroir Elementi a cassetti 42440.2	
 81897.3 800x420 mm	●	●		● /R Drawer element Schubladenelement Element tiroir Elementi a cassetti 42440.2	● /L Drawer element Schubladenelement Element tiroir Elementi a cassetti 42440.2	●	

- **can be combined with a washtop**
kann mit einer Waschtischplatte kombiniert werden
peut être combiné avec un plan de toilette
componibile con un piano d'appoggio

- M **can be combined with a central drawer element**
kann mit einem Schubladenelement mittig kombiniert werden
peut être combiné avec un élément tiroirs au milieu
componibile con un elemento a cassetti centrale

1600				2000			
							
42321.4	42321.1	42321.2	42325.3	42325.4	42325.1	42325.2	
●	●	●	●	●	●	●	
●	● /R Drawer element Schubladenelement Element tiroir Elementi a cassetti 42440.2, 42442.2	● /L Drawer element Schubladenelement Element tiroir Elementi a cassetti 42440.2, 42442.2	● /LR Drawer element Schubladenelement Element tiroir Elementi a cassetti 42440.2	● /M Drawer element Schubladenelement Element tiroir Elementi a cassetti 42440.2	● /R Drawer element Schubladenelement Element tiroir Elementi a cassetti 42440.2, 42442.2	● /L Drawer element Schubladenelement Element tiroir Elementi a cassetti 42440.2, 42442.2	
●	● /R Drawer element Schubladenelement Element tiroir Elementi a cassetti 42440.2, 42442.2	● /L Drawer element Schubladenelement Element tiroir Elementi a cassetti 42440.2, 42442.2	● /LR Drawer element Schubladenelement Element tiroir Elementi a cassetti 42440.2	● /M Drawer element Schubladenelement Element tiroir Elementi a cassetti 42440.2	● /R Drawer element Schubladenelement Element tiroir Elementi a cassetti 42440.2, 42442.2	● /L drawer element Schubladenelement Element tiroir Elementi a cassetti 42440.2, 42442.2	
●	● /R Drawer element Schubladenelement Element tiroir Elementi a cassetti 42440.2, 42442.2	● /L Drawer element Schubladenelement Element tiroir Elementi a cassetti 42440.2, 42442.2	● /LR Drawer element Schubladenelement Element tiroir Elementi a cassetti 42440.2	● /M Drawer element Schubladenelement Element tiroir Elementi a cassetti 42440.2	● /R Drawer element Schubladenelement Element tiroir Elementi a cassetti 42440.2, 42442.2	● /L Drawer element Schubladenelement Element tiroir Elementi a cassetti 42440.2, 42442.2	
	● /R Drawer element Schubladenelement Element tiroir Elementi a cassetti 42440.2, 42442.2	● /L Drawer element Schubladenelement Element tiroir Elementi a cassetti 42440.2, 42442.2	● /LR Drawer element Schubladenelement Element tiroir Elementi a cassetti 42440.2	● Drawer element Schubladenelement Element tiroir Elementi a cassetti 42440.2	● /R Drawer element Schubladenelement Element tiroir Elementi a cassetti 42440.2, 42442.2	● /L Drawer element Schubladenelement Element tiroir Elementi a cassetti 42440.2, 42442.2	

L **can be combined with one drawer element on the left**
kann mit einem Schubladenelement links kombiniert werden
peut être combiné avec un élément tiroirs à gauche
componibile con un elemento a cassetti a sinistra

R **can be combined with one drawer element on the right**
kann mit einem Schubladenelement rechts kombiniert werden
peut être combiné avec un élément tiroirs à droite
componibile con un elemento a cassetti a destra

ILBAGNOALESSI One



Washtop, 800 mm, including mounting brackets

Waschtischplatte 800 mm, inkl. Befestigungselemente
Plan de toilette, 800 mm, avec jeu de fixations inclus
Piano d'appoggio 800 mm, con elemento di fissaggio

42300.0
Without cut-out
Ohne Ausschnitt
Sans découpe
Senza taglio

42301.3
With central cut-out
Mit Ausschnitt in der Mitte
Avec découpe centrale
Con taglio al centro

Please state washbasin number in the order form.

Bitte bei der Bestellung die Artikelnummer des Waschtisches vermerken.

Veillez indiquer le numéro de référence du lavabo lors de la commande.

Al momento dell'ordine annotare il numero di articolo del lavabo.

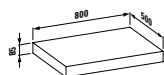

Colours: .630 .631



Washtop, 1200 mm, including mounting brackets

Waschtischplatte, 1200 mm, inkl. Befestigungselemente
Plan de toilette, 1200 mm, avec jeu de fixations inclus
Piano d'appoggio, 1200 mm, con elemento di fissaggio

42310.0
Without cut-out
Ohne Ausschnitt
Sans découpe
Senza taglio

42311.1
With cut-out left
Mit Ausschnitt links
Avec découpe à gauche
Con taglio a sinistra

42311.2
With cut-out right
Mit Ausschnitt rechts
Avec découpe à droite
Con taglio a destra

42311.3
With central cut-out
Mit Ausschnitt in der Mitte
Avec découpe centrale
Con taglio al centro

42311.4
With cut-out left and right
Mit Ausschnitt links und rechts
Avec découpe à gauche et à droite
Con taglio a sinistra et a destra

Please state washbasin number in the order form.

Bitte bei der Bestellung die Artikelnummer des Waschtisches vermerken.

Veillez indiquer le numéro de référence du lavabo lors de la commande.

Al momento dell'ordine annotare il numero di articolo del lavabo.

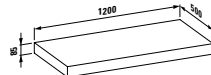

Colours: .630 .631



Washtop, 1600 mm, including mounting brackets

Waschtischplatte, 1600 mm, inkl. Befestigungselemente
Plan de toilette, 1600 mm, avec jeu de fixations inclus
Piano d'appoggio, 1600 mm, con elemento di fissaggio

42320.0
Without cut-out
Ohne Ausschnitt
Sans découpe
Senza taglio

42321.1
With cut-out left
Mit Ausschnitt links
Avec découpe à gauche
Con taglio a sinistra

42321.2
With cut-out right
Mit Ausschnitt rechts
Avec découpe à droite
Con taglio a destra

42321.3
With central cut-out
Mit Ausschnitt in der Mitte
Avec découpe centrale
Con taglio al centro

42321.4
With cut-out left and right
Mit Ausschnitt links und rechts
Avec découpe à gauche et à droite
Con taglio a sinistra et a destra

Please state washbasin number in the order form.

Bitte bei der Bestellung die Artikelnummer des Waschtisches vermerken.

Veillez indiquer le numéro de référence du lavabo lors de la commande.

Al momento dell'ordine annotare il numero di articolo del lavabo.



Colours: .630 .631



Washtop, 2000 mm, including mounting brackets

Waschtischplatte, 2000 mm, inkl. Befestigungselemente
Plan de toilette, 2000 mm, avec jeu de fixations inclus
Piano d'appoggio, 2000 mm, con elemento di fissaggio

42325.0
Without cut-out
Ohne Ausschnitt
Sans découpe
Senza taglio

42325.1
With cut-out left
Mit Ausschnitt links
Avec découpe à gauche
Con taglio a sinistra

42325.2
With cut-out right
Mit Ausschnitt rechts
Avec découpe à droite
Con taglio a destra

42325.3
With central cut-out
Mit Ausschnitt in der Mitte
Avec découpe centrale
Con taglio al centro

42325.4
With cut-out left and right
Mit Ausschnitt links und rechts
Avec découpe à gauche et à droite
Con taglio a sinistra et a destra

Please state washbasin number in the order form.

Bitte bei der Bestellung die Artikelnummer des Waschtisches vermerken.

Veillez indiquer le numéro de référence du lavabo lors de la commande.

Al momento dell'ordine annotare il numero di articolo del lavabo.



Colours: .630 .631

ILBAGNOALESSI One



42440.2

Drawer element 400 mm, for mounting under washtop, with 2 drawers, with soft close mechanism

Schubladenelement 400 mm, für Montage unter der Waschtischplatte, mit 2 Schubladen, mit Softclose
 Élément tiroir 400 mm, pour montage sous le plan de toilette, avec 2 tiroirs, avec mécanisme soft close
 Elemento a cassetto 400 mm, per montaggio sotto il piano di appoggio, con due cassetti, con Softclose

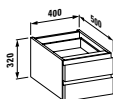

Colours: .630 .631



42442.2

Drawer element 800 mm, for mounting under washtop, with 2 drawers, with soft close mechanism

Schubladenelement 800 mm, für Montage unter der Waschtischplatte, mit 2 Schubladen, mit Softclose
 Élément tiroir 800 mm, pour montage sous le plan de toilette, avec 2 tiroirs, avec mécanisme soft close
 Elemento a cassetto 800 mm, per montaggio sotto il piano di appoggio, con due cassetti, con Softclose



Colours: .630 .631



Drawer element, with 12 mm top, for mounting on washtop, with 2 drawers, with soft close mechanism

Schubladenelement, mit 12 mm Platte, für Montage auf der Waschtischplatte, mit 2 Schubladen, mit Softclose
 Élément tiroir, avec plaque de 12 mm, pour montage sur le plan de toilette, avec 2 tiroirs, avec mécanisme soft close
 Elemento a cassetto, con piano di 12 mm, per montaggio sopra il piano di appoggio, con due cassetti, con Softclose

	A	B
43011.1	400	500
43012.1	400	350
43021.1	800	500
43022.1	800	350

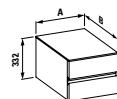

Colours: .630 .631

ILBAGNOALESSI One



42445.0
Vanity unit for washbasin 81497.6, with soft close mechanism, with 2 drawers

Waschtischunterbau für Waschtisch 81497.6, mit Softclose, mit 2 Schubladen

Meuble sous lavabo 81497.6, avec mécanisme soft close, avec 2 tiroirs
 Base sottolavabo per lavabo 81497.6, con Softclose, con 2 cassette

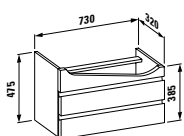

Colours: .630 .631



42447.0
Vanity unit for washbasin 81497.5, with soft close mechanism, with 2 drawers

Waschtischunterbau für Waschtisch 81497.5, mit Softclose, mit 2 Schubladen

Meuble sous lavabo 81497.6, avec mécanisme soft close, avec 2 tiroirs
 Base sottolavabo per lavabo 81497.6, con Softclose, con 2 cassette

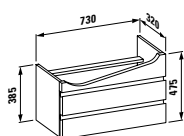

Colours: .630 .631



42450.0
Vanity unit for washbasin 81497.4, with soft close mechanism, with 2 drawers

Waschtischunterbau für Waschtisch 81497.4, mit Softclose, mit 2 Schubladen

Meuble sous lavabo 81497.4, avec mécanisme soft close, avec 2 tiroirs
 Base sottolavabo per lavabo 81497.4, con Softclose, con 2 cassette

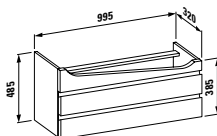

Colours: .630 .631



42452.0
Vanity unit for washbasin 81497.3, with soft close mechanism, with 2 drawers

Waschtischunterbau für Waschtisch 81497.3, mit Softclose, mit 2 Schubladen

Meuble sous lavabo 81497.3, avec mécanisme soft close, avec 2 tiroirs
 Base sottolavabo per lavabo 81497.3, con Softclose, con 2 cassette

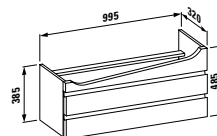

Colours: .630 .631

ILBAGNOALESSI One



42436.0

Vanity unit for washbasin 81497.1, with soft close mechanism, with 2 drawers

Waschtischunterbau für Waschtisch 81497.1, mit Softclose, mit 2 Schubladen

Meuble sous lavabo 81497.1, avec mécanisme soft close, avec 2 tiroirs

Base sottolavabo per lavabo 81497.1, con Softclose, con 2 cassetti

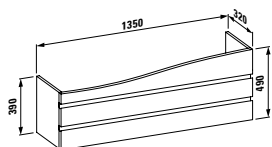

Colours: .630 .631



42405.3

Vanity unit for washbasin 81397.2, central cut-out, with space-saving siphon and soft close mechanism, with 1 drawer

Waschtischunterbau, für Waschtisch 81397.2, Ausschnitt in der Mitte, mit platzsparendem Siphon und Softclose, mit 1 Schublade

Meuble sous lavabo, pour lavabo 81397.2, découpe centrale, avec siphon gain de place et mécanisme soft close, avec 1 tiroir

Base sottolavabo, per lavabo 81397.2, taglio al centro, con sifone salvaspazio e Softclose, con 1 cassetto

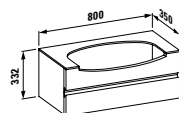

Colours: .630 .631



42415.1

Vanity unit for washbasin 81397.2, cut-out left, with space-saving siphon and soft close mechanism, with 3 drawers

Waschtischunterbau, für Waschtisch 81397.2, Ausschnitt links, mit platzsparendem Siphon und Softclose, mit 3 Schubladen

Meuble sous lavabo, pour lavabo 81397.2, découpe à gauche, avec siphon gain de place et mécanisme soft close, avec 3 tiroirs

Base sottolavabo, per lavabo 81397.2, taglio a sinistra, con sifone salvaspazio e Softclose, con 3 cassetti

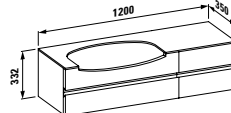

Colours: .630 .631



42415.2

Vanity unit for washbasin 81397.2, cut-out right, with space-saving siphon and soft close mechanism, with 3 drawers

Waschtischunterbau, für Waschtisch 81397.2, Ausschnitt rechts, mit platzsparendem Siphon und Softclose, mit 3 Schubladen

Meuble sous lavabo, pour lavabo 81397.2, découpe à droite, avec siphon gain de place et mécanisme soft close, avec 3 tiroirs

Base sottolavabo, per lavabo 81397.2, taglio a destra, con sifone salvaspazio e Softclose, con 3 cassetti

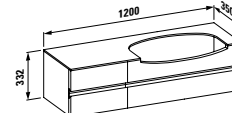

Colours: .630 .631

ILBAGNOALESSI One



Vanity unit, with central cut-out, with space-saving siphon and soft close mechanism

Waschtischunterbau, mit Ausschnitt in der Mitte, mit platzsparendem Siphon und Softclose

Meuble sous lavabo, avec découpe centrale, avec siphon gain de place et mécanisme soft close

Base sottolavabo, con taglio al centro, con sifone salvaspazio e Softclose

42402.3

For 81897.1, with 2 drawers

Für 81897.1, mit 2 Schubladen

Pour 81897.1, avec 2 tiroirs

Per 81897.1, con 2 cassetti

42403.3

For 81897.2, with 2 drawers

Für 81897.2, mit 2 Schubladen

Pour 81897.2, avec 2 tiroirs

Per 81897.2, con 2 cassetti

42404.3

For 81397.1, with 1 drawer

Für 81397.1, mit 1 Schublade

Pour 81397.1, avec 1 tiroir

Per 81397.1, con 1 cassetto

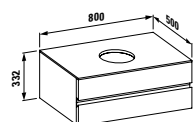

Colours: .630 .631



Vanity unit, with cut-out left, with space-saving siphon and soft close mechanism

Waschtischunterbau, mit Ausschnitt links, mit platzsparendem Siphon und Softclose

Meuble sous lavabo, avec découpe à gauche, avec siphon gain de place et mécanisme soft close

Base sottolavabo, con taglio a sinistra, con sifone salvaspazio e Softclose

42412.1

For 81897.1, with 4 drawers

Für 81897.1, mit 4 Schubladen

Pour 81897.1, avec 4 tiroirs

Per 81897.1, con 4 cassetti

42413.1

For 81897.2, with 4 drawers

Für 81897.2, mit 4 Schubladen

Pour 81897.2, avec 4 tiroirs

Per 81897.2, con 4 cassetti

42414.1

For 81397.1, with 3 drawers

Für 81397.1, mit 3 Schubladen

Pour 81397.1, avec 3 tiroirs

Per 81397.1, con 3 cassetti

42416.1

For 81897.3, with 4 drawers

Für 81897.3, mit 4 Schubladen

Pour 81897.3, avec 4 tiroirs

Per lavabo 81897.3, con 4 cassetti

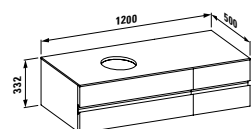

Colours: .630 .631



Vanity unit, with cut-out right, with space-saving siphon and soft close mechanism

Waschtischunterbau, mit Ausschnitt rechts, mit platzsparendem Siphon und Softclose

Meuble sous lavabo, avec découpe à droite, avec siphon gain de place et mécanisme soft close

Base sottolavabo, con taglio a destra, con sifone salvaspazio e Softclose

42412.2

For 81897.1, with 4 drawers

Für 81897.1, mit 4 Schubladen

Pour 81897.1, avec 4 tiroirs

Per 81897.1, con 4 cassetti

42413.2

For 81897.2, with 4 drawers

Für 81897.2, mit 4 Schubladen

Pour 81897.2, avec 4 tiroirs

Per 81897.2, con 4 cassetti

42414.2

For 81397.1, with 3 drawers

Für 81397.1, mit 3 Schubladen

Pour 81397.1, avec 3 tiroirs

Per 81397.1, con 3 cassetti

42416.2

For 81897.3, with 4 drawers

Für 81897.3, mit 4 Schubladen

Pour 81897.3, avec 4 tiroirs

Per lavabo 81897.3, con 4 cassetti

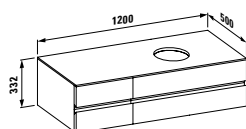

Colours: .630 .631



**42426.1
Vanity unit for washbasin 81897.3, with cut-out left, with 4 drawers, with space-saving siphon and soft close mechanism**

Waschtischunterbau, für Waschtisch 81897.3, mit Ausschnitt links, mit 4 Schubladen, mit platzsparendem Siphon und Softclose

Meuble sous lavabo, pour lavabo 81897.3, avec découpe à gauche, avec 4 tiroirs, avec siphon gain de place et mécanisme soft close

Base sottolavabo, per lavabo 81897.3, con taglio a sinistra, con 4 cassetti, con sifone salvaspazio e Softclose

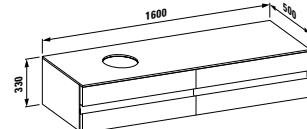

Colours: .630 .631

ILBAGNOALESSI One



42426.2
Vanity unit for washbasin 81897.3, with cut-out right, with 4 drawers, with space-saving siphon and soft close mechanism

Waschtischunterbau, für Waschtisch 81897.3, mit Ausschnitt rechts, mit 4 Schubladen, mit platzsparendem Siphon und Softclose

Meuble sous lavabo, pour lavabo 81897.3, avec découpe à droite, avec 4 tiroirs, avec siphon gain de place et mécanisme soft close

Base sottolavabo, per lavabo 81897.3, con taglio a destra, con 4 cassetti, con sifone salvaspazio e Softclose

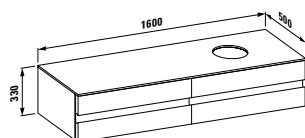

Colours: .630 .631



Vanity unit, with cut-out left and right, with space-saving siphon and soft close mechanism

Waschtischunterbau, mit Ausschnitt links und rechts, mit platzsparendem Siphon und Softclose

Meuble sous lavabo, avec découpe à droite et à gauche, avec siphon gain de place et mécanisme soft close

Base sottolavabo, con taglio a sinistra e a destra, sifone salvaspazio e Softclose

42422.4

For 81897.1, with 4 drawers

Für 81897.1, mit 4 Schubladen

Pour 81897.1, avec 4 tiroirs

Per 81897.1, con 4 cassetti

42424.4

For 81397.1, with 2 drawers

Für 81397.1, mit 2 Schubladen

Pour 81397.1, avec 2 tiroirs

Per 81397.1, con 2 cassetti

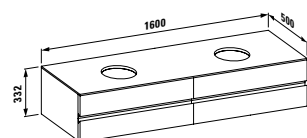

Colours: .630 .631

49240.2

Drawer organizer

Ordnungssystem für Schublade

Système de rangement pour tiroir

Sistema di messa in ordine per cassetto

Ordnungssystem für Schublade

Système de rangement pour tiroir

Sistema di messa in ordine per cassetto

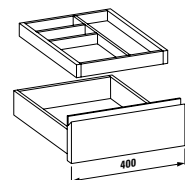
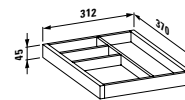

49240.1

Drawer organizer for small drawer

Ordnungssystem für kleine Schublade

Schublade

Système de rangement pour petit tiroir

tiroir

Sistema di messa in ordine per cassetto piccolo

Ordnungssystem für kleine Schublade

Schublade

Système de rangement pour petit tiroir

tiroir

Sistema di messa in ordine per cassetto piccolo

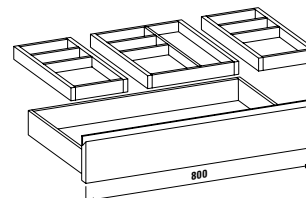
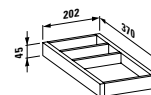

Not available for:

Nicht erhältlich für:

Non disponible pour:

Non disponibile per:

43012.1 / 43022.1 / 42405.3 / 42415.1 /

42415.2 / 42436.0

Colours: .630 .631

ILBAGNOALESSI One



Top for vanity unit

Deckplatte für Waschtischunterbau
Panneau pour meuble sous lavabo
Piano di appoggio per base de sottolavabo

42460.2

With cut-out left, for two vanity units with large drawers left

Mit Ausschnitt links, für zwei Unterbauten mit breiten Schubladen links
Avec découpe à gauche, pour deux meubles sous lavabo avec tiroirs larges à gauche
Con taglio a sinistra, per due base de sottolavabo con cassetti largi a sinistra

42460.3

With cut-out right, for two vanity units with large drawers left

Mit Ausschnitt rechts, für zwei Unterbauten mit breiten Schubladen links
Avec découpe à droite, pour deux meubles sous lavabo avec tiroirs larges à gauche
Con taglio a destra, per due base de sottolavabo con cassetti largi a sinistra

42460.4

With cut-out left and right, for two vanity units with large drawers left

Mit Ausschnitt rechts, für zwei Unterbauten mit breiten Schubladen links
Avec découpe à droite, pour deux meubles sous lavabo avec tiroirs larges à gauche
Con taglio a sinistra e a destra, per due base de sottolavabo con cassetti largi a sinistra

Please state washbasin number in the order form.

Bitte bei der Bestellung die Artikelnummer des Waschtisches vermerken.
Veuillez indiquer le numéro de référence du lavabo lors de la commande.
Al momento dell'ordine annotare il numero di articolo del lavabo.

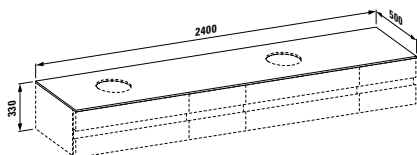

42417.0

Vanity unit, without top, with 4 drawers, with large drawers left, with space-saving siphon and soft close mechanism

Waschtischunterbau, ohne Deckplatte, mit breiten Schubladen links, mit 4 Schubladen, mit platzsparendem Siphon und Softclose
Meuble sous lavabo, sans plaque de couverture, avec 4 tiroirs, avec tiroirs larges à gauche, avec siphon gain de place et mécanisme soft close
Base sottolavabo, senza piano di appoggio, con 4 cassetti, con cassetti grandi a sinistra, con sifone salvaspazio e Softclose

42417.0

Vanity unit, without top, with 4 drawers, with large drawers left, with space-saving siphon and soft close mechanism

Waschtischunterbau, ohne Deckplatte, mit breiten Schubladen links, mit 4 Schubladen, mit platzsparendem Siphon und Softclose
Meuble sous lavabo, sans plaque de couverture, avec 4 tiroirs, avec tiroirs larges à gauche, avec siphon gain de place et mécanisme soft close
Base sottolavabo, senza piano di appoggio, con 4 cassetti, con cassetti grandi a sinistra, con sifone salvaspazio e Softclose

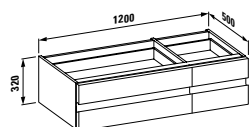
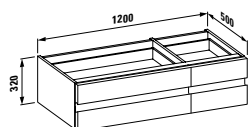

Colours: .630 .631



Top for vanity unit

Deckplatte für Waschtischunterbau
Panneau pour meuble sous lavabo
Piano di appoggio per base de sottolavabo

42461.2

With cut-out left, for two vanity units with large drawers right

Mit Ausschnitt links, für zwei Unterbauten mit breiten Schubladen rechts
Avec découpe à gauche, pour deux meubles sous lavabo avec tiroirs larges à droite
Con taglio a sinistra, per due base de sottolavabo con cassetti largi a destra

42461.3

With cut-out right, for two vanity units with large drawers right

Mit Ausschnitt rechts, für zwei Unterbauten mit breiten Schubladen rechts
Avec découpe à droite, pour deux meubles sous lavabo avec tiroirs larges à droite
Con taglio a destra, per due base de sottolavabo con cassetti largi a destra

42461.4

With cut-out left and right, for two vanity units with large drawers right

Mit Ausschnitt rechts, für zwei Unterbauten mit breiten Schubladen rechts
Avec découpe à droite, pour deux meubles sous lavabo avec tiroirs larges à droite
Con taglio a sinistra e a destra, per due base de sottolavabo con cassetti largi a destra

Please state washbasin number in the order form.

Bitte bei der Bestellung die Artikelnummer des Waschtisches vermerken.
Veuillez indiquer le numéro de référence du lavabo lors de la commande.
Al momento dell'ordine annotare il numero di articolo del lavabo.

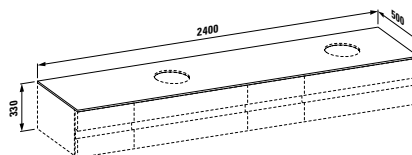

42418.0

Vanity unit, without top, with 4 drawers, with large drawers right, with space-saving siphon and soft close mechanism

Waschtischunterbau, ohne Deckplatte, mit breiten Schubladen rechts, mit 4 Schubladen, mit platzsparendem Siphon und Softclose
Meuble sous lavabo, sans plaque de couverture, avec 4 tiroirs, avec tiroirs larges à droite, avec siphon gain de place et mécanisme soft close
Base sottolavabo, senza piano di appoggio, con 4 cassetti, con cassetti grandi a destra, con sifone salvaspazio e Softclose

42418.0

Vanity unit, without top, with 4 drawers, with large drawers right, with space-saving siphon and soft close mechanism

Waschtischunterbau, ohne Deckplatte, mit breiten Schubladen rechts, mit 4 Schubladen, mit platzsparendem Siphon und Softclose
Meuble sous lavabo, sans plaque de couverture, avec 4 tiroirs, avec tiroirs larges à gauche, avec siphon gain de place et mécanisme soft close
Base sottolavabo, senza piano di appoggio, con 4 cassetti, con cassetti grandi a destra, con sifone salvaspazio e Softclose

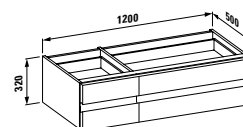
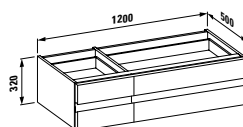

Colours: .630 .631

ILBAGNOALESSI One



Top for vanity unit

Deckplatte für Waschtischunterbau

Panneau pour meuble sous lavabo

Piano di appoggio per base de sottolavabo

42462.4

With cut-out left and right, for one vanity unit with large drawers right and for one vanity unit with large drawers left

Mit Ausschnitt links und rechts, für einen Unterbau mit breiten Schubladen rechts und für einen Unterbau mit breiten Schubladen rechts

Avec découpe à gauche et droite, pour un meuble sous lavabo avec tiroirs larges à droite et un meuble sous lavabo avec tiroirs larges à gauche

Con taglio a sinistra, per una base de sottolavabo con cassetti largi a destra una base de sottolavabo con cassetti largi a sinistra

Please state washbasin number in the order form.

Bitte bei der Bestellung die Artikelnummer des Waschtisches vermerken.

Veuillez indiquer le numéro de référence du lavabo lors de la commande.

Al momento dell'ordine annotare il numero di articolo del lavabo.

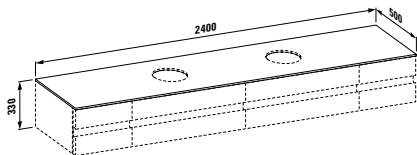

42418.0

Vanity unit, without top, with 4 drawers, with large drawers right, with space-saving siphon and soft close mechanism

Waschtischunterbau, ohne Deckplatte, mit breiten Schubladen rechts, mit 4 Schubladen, mit platzsparendem Siphon und Softclose

Meuble sous lavabo, sans plaque de couverture, avec 4 tiroirs, avec tiroirs larges à droite, avec siphon gain de place et mécanisme soft close

Base sottolavabo, senza piano di appoggio, con 4 cassetti, con cassetti grandi a destra, con sifone salvaspazio e Softclose

42417.0

Vanity unit, without top, with 4 drawers, with large drawers left, with space-saving siphon and soft close mechanism

Waschtischunterbau, ohne Deckplatte, mit breiten Schubladen links, mit 4 Schubladen, mit platzsparendem Siphon und Softclose

Meuble sous lavabo, sans plaque de couverture, avec 4 tiroirs, avec tiroirs larges à gauche, avec siphon gain de place et mécanisme soft close

Base sottolavabo, senza piano di appoggio, con 4 cassetti, con cassetti grandi a sinistra, con sifone salvaspazio e Softclose

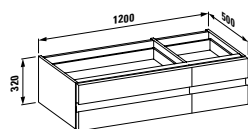
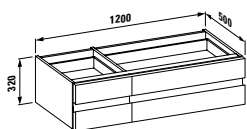

Colours: .630 .631

Colours furniture

Farben Möbel

Couleurs meubles

Colori dei mobili



.631 White lacquered

Weiss lackiert

Blanc laqué

Bianco laccato



.630 Noce canaletto

ILBAGNOALESSI One



Tall cabinet with mirror, 4 glass shelves

Hochschrank mit Spiegel, 4 Glasfachböden
Armoire haute avec miroir, avec 4 étagères en verre
Colonna con specchio, 4 ripiani di vetro

45801.1

Door hinge left

Scharnier links
Charnière de porte à gauche
Anta con apertura verso sinistra

45802.1

Door hinge right

Scharnier rechts
Charnière de porte à droite
Anta con apertura verso destra

45803.1

Door hinge left, with illuminated shelving

Scharnier links, mit beleuchteten Ablagen
Charnière de porte à gauche avec étagères éclairées
Anta con apertura verso sinistra, con mensole illuminate

45804.1

Door hinge right, with illuminated shelving

Scharnier rechts, mit beleuchteten Ablagen
Charnière de porte à droite avec étagères éclairées
Anta con apertura verso destra, con mensole illuminate

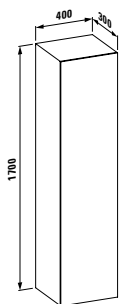

Colours: .630 .631



Tall cabinet with mirror, 2 glass shelves, 2 interior drawers

Hochschrank mit Spiegel, 2 Glasfachböden, 2 Innenschubladen
Armoire haute avec miroir, avec 2 étagères en verre, 2 tiroirs intérieurs
Colonna con specchio, 2 ripiani di vetro, 2 cassetti interni

45801.2

Door hinge left

Scharnier links
Charnière de porte à gauche
Anta con apertura verso sinistra

45802.2

Door hinge right

Scharnier rechts
Charnière de porte à droite
Anta con apertura verso destra

45803.2

Door hinge left, with illuminated shelving

Scharnier links, mit beleuchteten Ablagen
Charnière de porte à gauche avec étagères éclairées
Anta con apertura verso sinistra, con mensole illuminate

45804.2

Door hinge right, with illuminated shelving

Scharnier rechts, mit beleuchteten Ablagen
Charnière de porte à droite avec étagères éclairées
Anta con apertura verso destra, con mensole illuminate

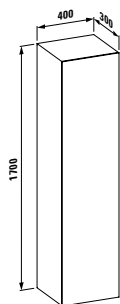

Colours: .630 .631



44841.1

Mirror, 400 mm, with lighting, mirror frame and anti-misting system, 2x8W, IP44, 230V

Spiegel, 400 mm, mit Beleuchtung, Spiegelrahmen und Anti-Beschlagssystem, 2x8W, IP44, 230V
Miroir, 400 mm, avec éclairage intégré, cadre et système anti-buée, 2x8W, IP44, 230V
Specchio, 400 mm, con illuminazione, telaio e sistema antiappannamento, 2x8W, IP44, 230V

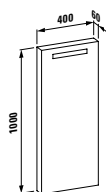

Colours: -



Mirror, with lighting, mirror frame and anti-misting system

Spiegel, mit Beleuchtung, Spiegelrahmen und Anti-Beschlagssystem
Miroir avec éclairage intégré, cadre et système anti-buée
Specchio, con illuminazione, telaio e sistema antiappannamento

	A
44842.1	800, 2x13 W
44843.1	1200, 1x28 W
44844.1	1600, 1x35 W

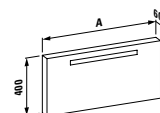

Colours: -

ILBAGNOALESSI One



Mirror cabinet, 650 mm, with lighting and anti fog system, 1x24W, IP44, 230V

Spiegelschrank, 650 mm, mit Beleuchtung und Anti-Beschlagsystem, 1x24W, IP44, 230V

Armoire de toilette avec miroir, 650 mm, éclairage intégré, cadre et système anti-buée, 1x24W, IP44, 230V

Armadietto a specchio, 650 mm, con illuminazione e sistema antiappannamento, 1x24W, IP44, 230V

44812.1

Side pull-out right, 1 switch, 1 socket EU

Seitlicher Auszug rechts, 1 Schalter, 1 Steckdose EU

Tiroir coulissant à gauche, 1 interrupteur, 1 prise UE

Ripiano estraibile a destra, 1 interruttore, 1 presa EU

44812.3

Side pull-out right, 1 switch, 1 socket CH

Seitlicher Auszug rechts, 1 Schalter, 1 Steckdose CH

Tiroir coulissant à gauche, 1 interrupteur, 1 prise CH

Ripiano estraibile a destra, 1 interruttore, 1 presa CH

44812.5

Side pull-out right, no switch, no socket

Seitlicher Auszug rechts, kein Schalter, keine Steckdose

Tiroir coulissant à gauche, pas d'interrupteur, pas de prise

Ripiano estraibile a destra, senza interruttore, senza presa

44811.1

Side pull-out left, 1 switch, 1 socket EU

Seitlicher Auszug links, 1 Schalter, 1 Steckdose EU

Tiroir coulissant à droite, 1 interrupteur, 1 prise UE

Ripiano estraibile a sinistra, 1 interruttore, 1 presa EU

44811.3

Side pull-out left, 1 switch, 1 socket CH

Seitlicher Auszug links, 1 Schalter, 1 Steckdose CH

Tiroir coulissant à droite, 1 interrupteur, 1 prise CH

Ripiano estraibile a sinistra, 1 interruttore, 1 presa CH

44811.5

Side pull-out left, no switch, no socket

Seitlicher Auszug links, kein Schalter, keine Steckdose

Tiroir coulissant à droite, pas d'interrupteur, pas de prise

Ripiano estraibile a sinistra, senza interruttore, senza presa

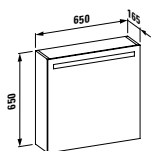

Colours: .630 .631



Mirror cabinet 800 mm, with lighting and side pull-out left and right, with anti fog system, 1x24W, IP44, 230V

Spiegelschrank 800 mm, mit Beleuchtung und seitlichem Auszug links und rechts, mit Anti-Beschlag-system, 1x24W, IP44, 230V

Armoire de toilette avec miroir, 800 mm, avec tiroir à gauche et à droite, système anti-buée, 1x24W, IP44, 230V

Armadietto a specchio 800 mm, con illuminazione e ripiani estraibili a sinistra e a destra, con sistema antiappannamento, 1x24W, IP44, 230V

44823.1

1 switch, 1 socket EU

1 Schalter, 1 Steckdose EU

1 interrupteur, 1 prise UE

1 interruttore, 1 presa EU

44823.3

1 switch, 1 socket CH

1 Schalter, 1 Steckdose CH

1 interrupteur, 1 prise CH

1 interruttore, 1 presa CH

44823.5

No switch, no socket

Kein Schalter, keine Steckdose

Pas d'interrupteur, pas de prise

Senza interruttore, senza presa

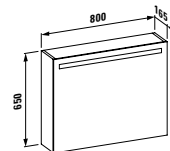

Colours: .630 .631

Colours furniture

Farben Möbel

Couleurs meubles

Colori dei mobili



.631 White lacquered

Weiss lackiert

Blanc laqué

Bianco laccato



.630 Noce canaletto



It is possible that not all products, sizes or colours are available in every country. Delivery periods may also differ in each case.

Unter Umständen sind nicht alle Produkte, Grössen oder Farben in jedem Land verfügbar. Auch die jeweiligen Lieferzeiten können von Land zu Land abweichen.

Il se peut que les produits ne soient pas tous disponibles dans chaque pays dans toutes les dimensions et coloris. Les délais de livraisons peuvent également varier d'un pays à l'autre.

È possibile che non tutti i prodotti, le misure e i colori siano ugualmente disponibili in ogni Paese. Anche i tempi di consegna possono variare da un Paese all'altro.

The illustrated colours only approximately correspond to the actual shades. The bathroom layouts shown here are purely decorative and do not reflect all the technical requirements. The decorative parts used are not included in our commercial offer. We reserve the right to make technical changes without prior notice. Registered design.

Die Farbabbildungen entsprechen nur in etwa den tatsächlichen Farbtönen. Die hier gezeigten Badmilieus sind rein dekorativ und berücksichtigen nicht alle technischen Anforderungen. Unser Angebot beinhaltet nicht die verwendete Dekoration. Technische Änderungen sind vorbehalten. Design geschützt.

Les photos couleur ne correspondent que partiellement aux teintes effectives. Les ambiances reproduites ici sont simplement décoratives, les exigences techniques d'installation n'ont pas toujours été prises en compte. La décoration utilisée ne fait pas partie de notre offre commerciale. Sous réserve de modifications techniques. Modèle déposé.

I colori qui illustrati non corrispondono esattamente alle tonalità effettive. Gli ambienti qui riprodotti sono puramente decorativi e non tengono conto di tutte le specifiche tecniche. Gli articoli d'arredo usati non fanno parte della nostra offerta commerciale. Con riserva di apportare modifiche tecniche. Modello depositato.

Printed on certified paper from sustainably managed forests.

Gedruckt auf zertifiziertem Papier. Aus nachhaltig bewirtschafteten Wäldern.

Imprimé sur du papier certifié. Issu de forêts exploitées de façon durable.

Stampato su carta certificata. Proveniente da boschi a gestione sostenibile.

Products with the Q-Plus certification comply with the European standard, as well as with the proven higher Swiss standard laid down by suissetec/VSA. LAUFEN ceramic products comply with this Swiss quality standard and are recommended accordingly.

Produkte mit der Q-Plus-Zertifizierung entsprechen einerseits der Europeanorm und andererseits zusätzlich dem bewährten, höheren Schweizer Standard, welcher durch die suissetec/VSA festgelegt wurde. LAUFEN Keramikprodukte entsprechen diesen schweizerischen Qualitätsmassstäben und haben die entsprechende Zulassungsempfehlung.

Les produits avec certification Q-Plus correspondent à la norme européenne et satisfont en plus aux standards suisses définis par la suissetec/VSA, encore plus élevés et qui ont largement fait leurs preuves. Les produits en céramique signés LAUFEN sont conformes à ces critères de qualité suisses et bénéficient donc des recommandations d'homologation correspondantes.

I prodotti con la certificazione Q-Plus sono conformi sia alla normativa europea sia allo standard svizzero, che prevede requisiti ancora più rigorosi, stabiliti dalla suissetec/VSA. I prodotti in ceramica LAUFEN rispettano questi criteri qualitativi svizzeri e dispongono della relativa certificazione di qualità.

Il Bagno Alessi is a complete bathroom installation concept that was produced by two of Europe's leading manufacturers in the range of bathrooms: the Swiss LAUFEN (sanitary ceramics, bathtubs, furniture and ceramic accessories) and the Finnish ORAS (fittings).

Il Bagno Alessi ist ein komplettes Einrichtungskonzept fürs Badezimmer, das von zwei der führenden europäischen Hersteller im Bereich Badezimmer produziert wurde: vom Schweizer LAUFEN (Sanitärkeramik, Badewannen, Möbel und keramische Accessoires) und dem finnischen ORAS (Armaturen).

Il Bagno Alessi est un concept d'aménagement complet pour la salle de bains produit par deux des fabricants d'éléments pour salle de bains leaders européens: le suisse LAUFEN (céramique sanitaire, baignoires, meubles et accessoires en céramique) et le finlandais ORAS (robinetterie).

Il Bagno Alessi è un progetto completo per la stanza da bagno, prodotto da due aziende europee leader nel settore degli elementi per il bagno: la svizzera LAUFEN (ceramiche sanitarie, vasche da bagno, mobili e accessori in ceramica) e la finlandese ORAS (rubinetteria).

www.alessi.com
www.oras.com



SaphirKeramik

The innovative SaphirKeramik mixture, which is filed for patent, permits the creation of wafer-thin yet robust walls and tight-edged radii of just 1–2 mm (state-of-the-art technology values are currently a minimum of 7–8 mm). The new ceramic is perceptibly sturdier and has greater flexural strength. Its slender profile renders it space-saving, lightweight and environmentally friendly.

Die innovative und zum Patent angemeldete Rezeptur von SaphirKeramik erlaubt Entwürfe mit hauchdünnen, doch robusten Wandungen sowie eng definierte Radien von nur 1–2 mm (bisher war ein Minimumwert von 7–8 mm State-of-the-Art). Die neue Keramik ist deutlich härter und hat eine grössere Biegefestigkeit. Durch ihr schlankes Profil ist sie platzsparend, leicht und umweltfreundlich.

La formule innovante et précieuse SaphirKeramik, brevet PCT en phase d'approbation, permet de réaliser des arêtes avec un rayon de 1 à 2 mm (jusqu'à présent, une valeur minimale de 7 à 8 mm était considérée comme le nec plus ultra). La nouvelle céramique est nettement plus dure et résistante à la flexion. Grâce à son profil étroit, elle économise d'espace, est légère et écologique.

L'innovativa e pregiata ricetta di SaphirKeramik, brevetto PCT in fase di approvazione, permette di ottenere raggi di soli 1–2 mm (allo stato dell'arte era finora possibile ottenere raggi di 7–8 mm). Questo nuovo tipo di ceramica è notevolmente più duro e possiede una maggiore resistenza alla flessione. Il profilo sottile dona al materiale una maggiore leggerezza, una migliore ottimizzazione degli ingombri e compatibilità ecologica.

Headquarters:

LAUFEN Bathrooms AG
Wahlenstrasse 46
CH-4242 Laufen
Tel. +41 61 765 71 11
Fax +41 61 761 36 60
feedback@laufen.ch
www.laufen.com

Export:

LAUFEN Bathrooms AG
Wahlenstrasse 46
CH-4242 Laufen
Tel. +41 61 765 76 09
Fax +41 61 765 77 77
export@laufen.ch
www.laufen.com/export

Asia:

Roca Sanitaryware Ltd.
Room 2303, 23/F
148 Electric Road
North Point, Hong Kong
Tel. +852 250 624 38
Fax +852 250 624 92
laufenasia@hongkong.laufen.ch
www.laufen.com/export

Oceania:**Australia, New Zealand & other**

Roca Bathroom Products
Australia P/L
Level 10, Suite 1004
46 Market Street
Sydney NSW 2000
Australia
Tel. +61 (2) 9290 2331
Fax +61 (2) 9290 2786
aus.admin@roca.net
www.laufen.com.au

Austria:

LAUFEN Austria AG
Mariazeller Strasse 100
A-3150 Wilhelmsburg
Tel. +43 2746 6060
Fax +43 2746 6060 380
office.wi@at.laufen.com
www.laufen.co.at

**Bosnia and Herzegovina,
Croatia, Kosovo, Macedonia,
Montenegro, Serbia, Slovenia:**

INKER d.d.
Industrijska 1
10290 Zaprešić
Tel. +385 1 3310 364
Fax +385 1 3310 275
komercijala@inker.hr
www.hr.laufen.com

Benelux:

LAUFEN Benelux B.V.
Meidoornkade 2A
NL-3992 AE Houten
Tel. +31 (0)33 450 20 90
Fax +31 (0)33 450 20 91
info.benelux@laufen.ch
www.laufen.nl
www.laufen.be

Brazil:

Roca Sanitários Brasil Ltda.
Av. 14 de Dezembro,
2.800 - V. Mafalda
CEP: 13206-105
Jundiá - SP - Brasil
PABX: +55 11 3378 4600
Assistência Técnica: 0800 70 11 510
Fax +55 11 4587-2324
info.br@laufen.com
www.laufen.com/br

Bulgaria:

Roca Bulgaria AD
5, Pirotska Str.
1301 Sofia, Bulgaria
Tel. +359 2 930 59 10
Fax +359 2 930 59 18
office.sofia@bg.roca.net
www.bg.roca.com

China:

Roca Sanitary Trading
(Shanghai) co. Ltd
Room 503-505, City Gateway
No. 396 North Caoxi Road
Shanghai 200030, China
Tel. +86 21 3368 8822
Fax +86 21 3368 8299
laufen_cn@roca.net.cn
www.cn.laufen.com

Czech Republic:

LAUFEN CZ s.r.o.
V Tűnich 3/1637
120 00 Praha 2
Tel. +420 296 337 711
galerie@cz.laufen.com
www.laufen.cz

Estonia, Latvia:

LAUFEN CZ s.r.o.
Pae 25-8
Tallinn, 11414
Estonia
Tel./Fax +372 6 215 569
office.tallinn@ee.laufen.com
www.laufen.com

France:

Roca S.A.R.L.
Marque LAUFEN
Immeuble le Rond Point
5 Boulevard de l'Oise
F-95015 Cergy Pontoise Cédex
Tel. +33 1 34 40 39 31
Fax +33 1 30 37 02 65
commercial@laufen-france.com
www.laufen.com/fr

Germany:

Roca GmbH
Vertrieb LAUFEN
Feincheswiese 17
56424 Staudt
Germany
Tel. +49 26 02 / 94 93 33
Fax +49 26 02 / 94 93 355
info.staudt@de.laufen.com
www.de.laufen.com

Hungary:

LAUFEN CZ s.r.o.
Hungarian Trade Agency
Pasaréti u. 83
H-1026 Budapest
Tel. +36 1 274 05 35
Fax +36 1 391 04 58
office.budapest@hu.laufen.com
www.laufen.com

India:

Roca Bathroom Products Pvt. Ltd.
3rd Floor, Tower B,
DLF Building No. 10, Phase – II
DLF Cyber City,
Gurgaon – 122002, Haryana
India
Tel. +91 124 4278347-49
Fax +91 124 4278350
Info.laufen@in.roca.com
www.laufen.com/export

Italy:

LAUFEN CZ s.r.o.
V Tűnich 3/1637
CZ-120 00 Praha 2
Tel. +39 02 90016001
Fax. +39 02 90016011
www.it.laufen.com
info@laufen.it

Lithuania:

LAUFEN CZ s.r.o.
Užupio g. 30
Vilnius, 01203
Lietuva
Tel. +370 5 215 30 76
office.vilnius@lt.laufen.com
www.laufen.lt

Morocco:

Roca Maroc, S.A.
route de Marrakech, km 2,5
BP 571, 26000 Settat
Tel. +212 5 23 40 59 41
Fax +212 5 23 40 59 42
www.roca.com

Nordic Countries:**Denmark, Finland, Sweden**

LAUFEN Nordic Aps
Tømrenvej 2
4600 Køge
Denmark
Tel. +45 56 287 287
Fax +45 56 287 237
info@dk.laufen.com
www.laufen.dk
www.laufen.fi
www.laufen.se

North America:

LAUFEN Bathrooms North America
Showroom
7610 NE 4th Court, Suite 104
Miami, FL 33138
USA
Toll free phone +1 (866) 696-2493
+1 (305) 357-6130
Toll free fax +1 (866) 628-1760
usa@laufen.com
canada@laufen.com
www.laufen.com/usa
www.laufen.com/ca
www.laufen.com.mx

Norway:

Laufen Norge AS
Syretårnet 41
NO-3048 Drammen
Tel.: +47 32 27 60 70
firmapost@no.laufen.com
www.laufen.no

Poland:

Roca Polska Sp. z o.o.
ul. Wyczółkowskiego 20
44-109 Gliwice
Tel. +48 32 339 41 00
Fax +48 32 339 41 01
biuro@roca.pl
www.laufen.pl

Portugal:

Roca, S.A., Portugal
Apartado 575, Ponte da Madalena
2416-905 - Leiria, Portugal
Tel. +351 244 720 000
Fax +351 244 722 373
marketing.le@pt.roca.net
www.laufen.pt

Romania:

Roca Obiecte Sanitare S.R.L.
Blvd. Preciziei nr. 1, Sector 6
062202 - Bucharest - Romania
Tel. +4031 822 2310
Fax +4021 318 1418
www.ro.roca.com

Russia:

Roca Rus
Promyshlennaya Str. 7, Tosno
Leningrad region, 187000, Russia
Tel. +7 812 347 94 49
Fax +7 812 347 94 50
marketing@ru.roca.net
www.laufen.ru

Roca Rus

2nd Hutorskaya, 38A, building 14
Moscow, 127287, Russia
Tel. +7 495 989 65 91
Fax +7 495 959 65 93
marketing@ru.roca.net
www.laufen.ru

Slovakia:

LAUFEN SK s.r.o.
Štefanovičova 12,
811 04 Bratislava
Tel. +421 2 52 621 024
www.sk.laufen.com

Spain:

Laufen Bathrooms S.A.
C/Covarrubias 23
28010 Madrid
Spain
Phone: +34 900 103 258
info@es.laufen.com
www.laufen.com/es

Sweden:

Laufen Sverige AB
Kämpvegatan 15
SE-41104 Göteborg
Tel. +46 (0) 823 44 44
info@se.laufen.com
www.laufen.se

Switzerland:

Keramik Laufen AG
Wahlenstrasse 46
CH-4242 Laufen
Tel. +41 61 765 71 11
Fax +41 61 761 29 22
forum@laufen.ch
www.laufen.ch

Ukraine:

LAUFEN CZ s.r.o. Ukraine
Kiev 04128
19, Ak. Tupoleva str., office „Laufen“
Tel. +380 44 499 0620
Fax +380 44 499 0621
office.kiev@ua.laufen.com
www.laufen.net.ua

United Kingdom and Ireland:

LAUFEN Ltd.
c/o Roca Ltd.
Samson Road
Hermitage Industrial Estate
Coalville
Leicestershire
LE67 3FP
Tel. +44 (0)1530 510007
Fax +44 (0)1530 838949
info@uk.laufen.com
www.uk.laufen.com

Art Direction / Graphic Design RADL, Milano – Photos Fabrizio Bergamo – Styling Tiziano Alderighi with Camilla Brighi
Print Grafiche Antiga – Thanks to: B&B Italia, Gabel, Kasthall, MDF Italia, Muji, My fragrances, Oras



LAUFEN Bathrooms AG
Wahlenstrasse 46
4242 Laufen, Switzerland
www.laufen.com

ALESSI is a registered trademark of
ALESSI S.p.A. 28887 Crusinallo (VB), Italy.
All products of ILBAGNOALESSI are
produced under license of ALESSI S.p.A.
www.ilbagnoalessi.com

LAUFEN

T.0015.I.001.403.1/Antiga/06.2016